





SKU: BV5167

-  Mars Series 88 Ball Valve – Stainless Steel - FSAS
-  Mars Serie 88 Kugelhahn - Rostfreier Stahl - FSAS
-  Serie Mars válvula de bola 88 - Acero inoxidable - FSAS
-  Mars Série 88 Ball Valve - Acier inoxydable - FSAS

Valves[™]
O N L I N E

- 1/4 " - 4" Heavy duty three piece ball valve
- 1/4 " - 4" Schwerlast drei Stück Kugelhahn
- 1/4 " - 4" Para trabajo pesado de tres piezas válvula de bola
- 1/4 " - 4" Heavy duty trois pièces vanne à boisseau sphérique



- **3 Piece Encapsulated Body Bolts**
- **Firesafe and Anti-Static**
- **Heavy Duty High Performance Ball Valve**
- **Body in Stainless Steel**
- **ISO Mounting Pad for Easy Actuation**
- **Pressure Rating up to 2000 PSI**
- **ATEX Approved**

MARS Series 88 heavy duty 3 piece ball valve, Reduced or Full bore supplied in carbon steel and fitted with carbon filled reinforced PTFE seats and seals. The valve has a unique encapsulated body bolt design and offers a raised ISO mounting pad with a square stem top for direct mounting for actuation. A Lockable lever can be supplied for manual operation The body seals can be replaced/maintained in line by dropping the swing out body without disassembly. This valve is **Fire safe and Antistatic**. Ends come in either BSPP, NPT, Socket Weld and Butt weld (SCHD 40)

**MARS Series 88
Stainless Steel Ball Valve**

**Easy to Actuate with
Direct ISO Mounting Pad**

**FIRE SAFE AND
ANTI – STATIC
API 607 4th Edition
Certified**



Description

Mars series 88 is a high performance ball valve that is fully maintainable. Offered in full or reduced bore with a raised direct mount ISO pad for actuation.
1/4" - 1" – 2000 PSI
1 1/4" - 2" – 1500 PSI
2 1/2" - 4" – 1000 PSI



Beschreibung

Mars Serie 88 ist ein Hochleistungs-Kugelhahn , die voll wartbar ist . Mit einem erhöhten Direktanbau ISO -Pad zur Ansteuerung Angeboten in voller oder reduzierter Bohrung .
1/4 " - 1 " - 2000 psi
1 1/4 " - 2 " - 1500 psi
2 1/2 " - 4 " - 1000 PSI



Descripción

Mars serie 88 es una válvula de bola de alto rendimiento que es totalmente mantenible . Se ofrece en paso total o reducido con una almohadilla de montaje ISO directa planteado para el accionamiento .
1/4 " - 1 " - 2000 PSI
1 1/4 " - 2 " - 1500 PSI
2 1/2 " - 4 " - 1000 PSI



Description

Série Mars 88 est une vanne à boisseau sphérique de haute performance qui est entièrement maintenable . Offert en passage intégral ou réduit avec un tampon direct soulevé montage ISO pour l'actionnement .
1/4 " - 1 " - 2000 PSI
1 1/4 " - 2 " - 1500 PSI
2 1/2 " - 4 " - 1000 PSI



Mars Series 88 Ball Valve – Stainless Steel - FSAS
 Mars Serie 88 Kugelhahn - Rostfreier Stahl - FSAS
 Serie Mars válvula de bola 88 - Acero inoxidable - FSAS
 Mars Série 88 Ball Valve - Acier inoxydable - FSAS

ValvesTM ONLINE

Mars series 88 ball valve

BREAKAWAY TORQUE & C.V.					
Size		Break Away Torque N/M		C.V. (G.P.M.)	
inches	DN	Full	Red.	Full	Red.
1/4"	8	8	8	8	8
3/8"	10	8	8	8	8
1/2"	15	8	8	15	8
3/4"	20	10	10	34	15
1"	25	16	10	56	34
1 1/4"	32	23	16	85	56
1 1/2"	40	33	23	125	85
2"	50	47	33	250	125
2 1/2"	65	62	47	320	250
3"	80	101	62	580	350
4"	100	114	101	1020	580

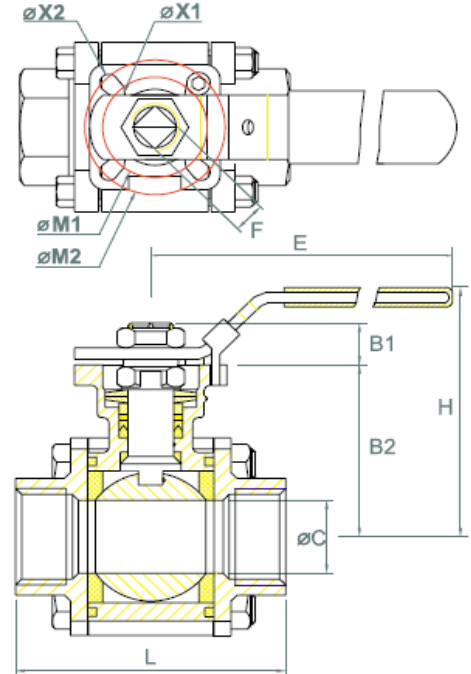
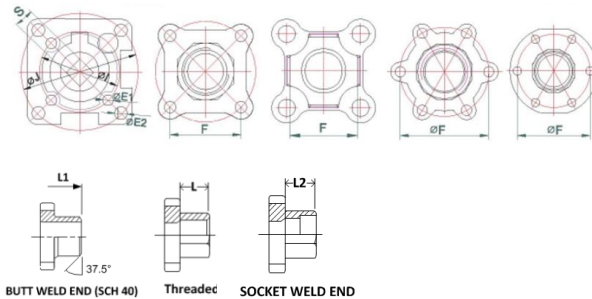





Dimensions Reduced Bore

Size	L	L1	L2	B1	B2	H	E	F	ISO 5211	Weight
1/4"	USE FULL BORE									
3/8"	USE FULL BORE									
1/2"	72.5	75	10	6.4	42.6	78	139	9	F03 & F04	0.89
3/4"	72.5	74.8	13	6.4	42.6	78	139	9	F03 & F04	0.82
1"	85.4	89.8	13	8.5	46.9	82.6	139	9	F03 & F04	1.29
1 1/4"	105.3	109.4	13	10.4	59.3	98.5	165	11	F04 & F05	2.01
1 1/2"	111	114.4	13	10.4	62.6	101.8	165	11	F04 & F05	2.76
2"	127.3	142.8	16	13.4	79	127	215	14	F05 & F07	4.21
2 1/2"	142.8	185	16	13.4	87.7	135.6	215	14	F05 & F07	5.83
3"	185	205	16	16.8	108.7	167	262	17	F07 & F10	12
4"	205	240	20	17.8	117.7	176	262	17	F07 & F10	16.2

Dimensions Full Bore

Size	L	L1	L2	B1	B2	H	E	F	ISO 5211	Weight
1/4"	72.5	75	10	6.4	42.6	78	139	9	F03 & F04	0.89
3/8"	72.5	75	10	6.4	42.6	78	139	9	F03 & F04	0.89
1/2"	72.5	75	10	6.4	42.6	78	139	9	F03 & F04	0.82
3/4"	85.4	90	13	8.6	46.9	82.6	139	9	F03 & F04	1.29
1"	105.3	110	13	10.4	59.3	98.5	165	11	F04 & F05	2.01
1 1/4"	111	115	13	10.4	62.6	101.8	165	11	F04 & F05	2.76
1 1/2"	127.3	130	13	13.4	79	127	215	14	F05 & F07	4.21
2"	142.8	143	16	13.4	87.7	135.6	215	14	F05 & F07	5.83
2 1/2"	185	185	16	16.8	108.7	167	262	17	F07 & F10	12
3"	205	205	16	17.8	117.7	176	262	17	F07 & F10	16.2
4"	240	240	20	16.8	133.7	192.7	312	17	F07 & F10	25.8

-  Mars Series 88 Ball Valve – Stainless Steel - FSAS
-  Mars Serie 88 Kugelhahn - Rostfreier Stahl - FSAS
-  Serie Mars válvula de bola 88 - Acero inoxidable - FSAS
-  Mars Série 88 Ball Valve - Acier inoxydable - FSAS

Mars series 88 ball valve

- 3 Piece Encapsulated Body Bolts
- Firesafe and Anti-Static
- Heavy Duty High Performance Ball Valve
- Body in Stainless Steel
- ISO Mounting Pad for Easy Actuation
- Pressure Rating up to 2000 PSI
- ATEX Approved

End connection Options

Socket Weld
Butt Weld (sch40)
NPT and BSPP

Options

Fire Safe and Anti Static Approval
Stainless Steel filled PTFE seats
V Sector Balls
Switches Fitted
Spring Closed Handle

ATEX 94/9/EC
CE – 0035
PED/97/23/EC



Technical and Parts List			
No.	Part Name	Material	Qty
1	Body	CF8M	1
2	End Cap	CF8M	2
3	Ball	SUS316	1
4	Stem	SUS316	1
5	Stem Nut	SUS304	1
6	Belleville washer	SUS301	1
7	Handle	SUS304	1
8	Ball Seat	Carbon Filled PTFE	2
9	Gland	SUS304	1
10	V-Ring Packing	MG1241	1
11	Stem Seal	Carbon Filled PTFE	1
12	Lock Saddle	SUS304	1

Specification	
Pressure range	1/4" to 1" 2000 PSI 1 1/4" to 2" 1500 PSI 2 1/2" to 4" 1000 PSI
Size	1/4" to 4" Full Bore, 1/2" to 4" Reduced Bore
Temperature range	minus 20° to + 200° (see graph)
Movement	90 deg turn
Cycle life	1,000,000 operations
Standard Approvals/Compliance	Fire-Safe Certified to 607 4th Edition ANSI B16.34, B16.25, B1.20.1, API 6D, 598, ISO 5029, 5211, 5752, DIN 3337, 3357, 50.049 Test Cert. EN 10204/DIN 50.049-31B
Options	TA-Luft, NACE MR-0175,

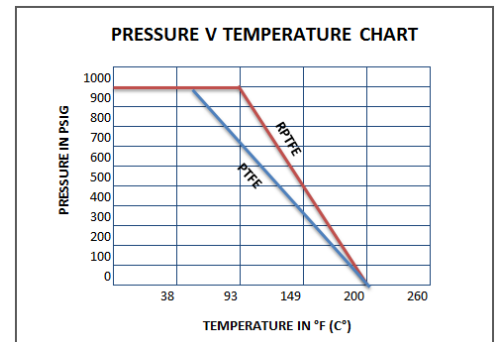





Bore or Port Dimensions of Valves											
Size	1/4"	3/8"	1/2"	3/4"	1"	1 1/4"	1 1/2"	2"	2 1/2"	3"	4"
ØF Full	38.2	38.2	38.2	44.3	50	57.2	66.6	114	139	160	193
ØF Reduced	X	X	38.2	38.2	44.3	50	57.2	66.6	114	139	160



Type AP9001 ATEX
Pneumatic Actuator



Type AP9004
Explosion Proof
Electric Actuator

-  Mars Series 88 Ball Valve - FSAS
-  Mars Serie 88 Kugelhahn - FSAS
-  Serie Mars válvula de bola 88 - FSAS
-  Mars Series 88 Ball Valve - FSAS

Mars series 88 ball valve

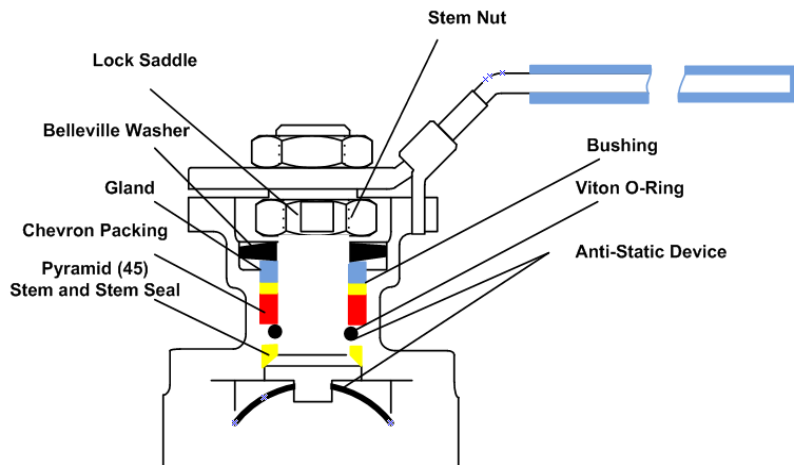

Mars Unique SealMax Tripple Sealing Stem Packing System Live Loaded Maintenance Free Extra Long Cycle Life TA Luft Approved

1. Pyramid Stem wth Stem Seal
2. V Ring Stem Packing
3. Lock Saddle
4. Stem Nut
5. Belleville Washers
6. Gland
7. Anti-Static Device
8. Super Smooth Stem Finish

Options
Fire Safe and Anti-Static
versions available
V Port Balls
Stainless Steel and Titanium
Bodies